

GalvinCare® Anti-Ligature Grab Rail

Specification Data Sheet

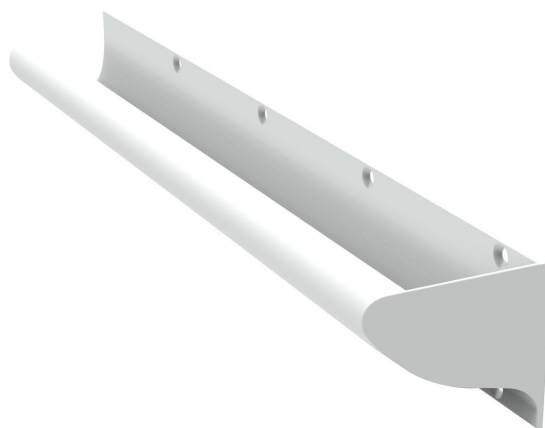

Features

- Anti-ligature features.
- Standard epoxy coated white finish to help create a more normalised environment.
- One end of the grab rail has an angled cap to prevent ligatures. This is installed at the top of a vertical rail or whichever end of a horizontal rail is most convenient.
- One end remains open for easy drainage and cleaning. This minimises infection control risks associated with other in-filled grab rails.
- Easy to use - To grip the handrail correctly the fingers should curl round the bar with the thumb supporting from the outside.
- Generally meets the requirements as fit for purpose of AS 1428.1-2009.
- Available in other colours such as Shale Grey, Black Glass, Cottage Green, Wineberry, Pommel Blue (must be specified when ordering).

To Specify

The GalvinCare® range of Anti-ligature grab rails provides safe and reliable fixtures for WC's and accessible areas in mental health institutions, psychiatric clinics, hospitals and detention facilities, which helps mitigate the possibility of self-harm by users and patients.

Code:

42235 - GalvinCare® Anti-ligature Grab Rail 700mm with Powder Coated Finish - LH (Vert or Horiz)



A family
owned
Australian
business



Performance Standards & Approvals

- Complies with requirements for AS 1428.1-2009

Available Finishes



Typical Dimensions

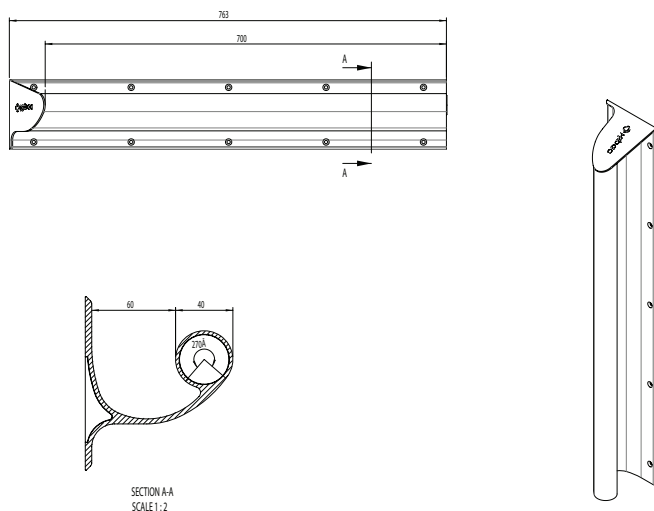

Technical Information

- Configuration: Available in lengths up to 6m in length. Can be mitre joined at 30, 45, or 90 degrees
- Fixings: Rails have countersunk fixing points to suit 12G Screw head
- Finishes: Powder Coated

Maintenance & Cleaning

Galvin Specialised products should be cleaned with a soft damp cloth using only mild liquid detergent or soap and water. Do not use cleaning agents containing a corrosive acid, scouring agent or solvents. Do not use cream cleaners, as they are abrasive. Use of unsuitable cleaning agents may damage the surface. Any damage caused in this way will not be covered by warranty.

Regular maintenance should be carried out in accordance with the installation and troubleshooting guides provided with the product, relevant Australian Standards, local authorities and state codes.

As part of maintaining a safe and reliable plumbing system, we recommend tapware and valves are operated on at least a daily basis.

Warranty

Galvin Engineering products are covered under our Manufacturer's Warranty at www.galvinengineering.com.au. Galvin Engineering products must be installed in accordance with the installation instructions and in accordance with AS3500 and the PCA, relevant Australian Standards and local authorities applicable to product being installed. Water and electrical supply conditions must also comply to the applicable national and/or state standards, failing to comply with these provisions may void the product warranty and affect performance of the product.

In the absence of a legal or industry definition of anti-ligature or ligature resistant products, when we use these terms, we are referring to products that are designed and manufactured with the intention of reducing the risk of ligature attachment to the product(s). Galvin Engineering Pty Ltd will always endeavour to design and test our anti-ligature product(s) to reduce the risk of product ligature attachment that may result in serious injury or death. Whilst all reasonable measures are taken at the time of design, the anti-ligature design of the products are not intended to and will not:

- Replace protective measures that need to be taken in the specific circumstances of usage;
- Substitute the need for supervision of those who may be at risk;
- Protect and or prevent those at risk against any self-harm instances that may occur when installed; and
- Protect and or prevent injury when the risks where unknown to us at the time of the design of the product(s).

Galvin Engineering Pty Ltd does not offer and does not represent or warrant that any product(s) for sale that are ligature-free. Therefore, Galvin Engineering will not be liable for any claims, loss, or damages arising from ligature attachment on our products. It is the purchaser's responsibility to ensure that products purchased and installed are suitable for the environments in which they are installed, and suitable supervision and protective measures are in place to protect those at risk.

Whilst all reasonable care has been taken in compiling the information in this document, the designs, dimensions and products shown are indicative only and should not be relied upon without our prior approval. Due to our policy of continuous development, we reserve the right to alter any details of specifications or products without notice. All information, drawings, technical specifications and product designs remains the property of Galvin Engineering Pty Ltd.

Within Australia: **1300 514 074** Outside Australia: P: +61 (0)8 9338 2344

F: +61 (0)8 9338 2340

sales@galvinengineering.com.au

www.galvinengineering.com.au

ABN: 78 008 719 382

A business unit of

GalvinEngineering
the mark of reliability



PERTH | SYDNEY | MELBOURNE | BRISBANE | ADELAIDE | UNITED STATES OF AMERICA | UNITED KINGDOM | NEW ZEALAND