

Product Installation Guidelines

Document No.: 001.00.20.00
Version 1, 29th March 2023, Page 1 of 5

GalvinCare[®] CP-BS Lead Safe Mental Health A/Ligature Paddle Handle WTA Comp ¼ Turn CD

PRODUCT CODES:

- 120.71.16.01 - Cold
- 120.71.16.02 - Hot



SPECIFICATIONS

- Designed for maximum protection against vandalism, Galvincare[®] Mental Health Wall Top Assemblies are made from heavy duty components and are designed to be ligature resistant for added safety.
- The paddle design handle allows the ceramic cartridge to be activated with minimal effort.
- Quarter turn ceramic disc.
- Machined cold or hot identification button.
- Lead Safe[™] brass construction*

IMPORTANT: All GalvinCare[®] Mental Health Wall Top Assemblies are tested in accordance with AS/NZS 3718 and leave our premises in good working order.

*As 'lead free' is not currently defined by law in Australia and New Zealand, we have based our definition of Lead Safe[™] on the requirements of Sec1417 of the USA's Safe Drinking Water Act (SDWA) and the relevant US standards NSF61 / NSF372. The SDWA defines 'lead free' as "not more than a weighted average of 0.25% lead when used with respect to the wetted surface of pipes, pipe fittings, plumbing fittings and fixtures".

WARNINGS: Special attentions to be paid on notes, photos, images, or drawings of assembly steps marked with the warning symbol.



TECHNICAL DATA

Inlet	5/8" BSP - Male	
Outlet	N/A	
Headwork	Ceramic	
Working Pressure Range (kPa)	Min	50
	Max	500
Working Temperature Range (°C)	Min	5
	Max	65
Nominal Flow Rate (LPM)	N/A	
Finish	Chrome	

NOTE: Galvin Engineering continually strive to improve their products. Specifications may change without notice.

TOOLS REQUIRED

- Spanner and 2.5mm hex key - to suit grab screw

PRE-INSTALLATION

MOUNTING DETAILS

Note: Before installation, all lines must be flushed. We recommend that a line strainer be installed prior to taps to eliminate any foreign material.

Wall body

- The maximum distance allowed from the face of the inwall wall body/breach to the finished wall is 10mm. If the wall finish is greater than 10mm from the face of the wall body/breach, then 20mm spindle extensions (Item #121.90.10.09) are available. Call 1300 514 074 for more information.
- The thread of the inwall assembly must be 5/8" Female.

INWALL BODY POSITION REQUIREMENT

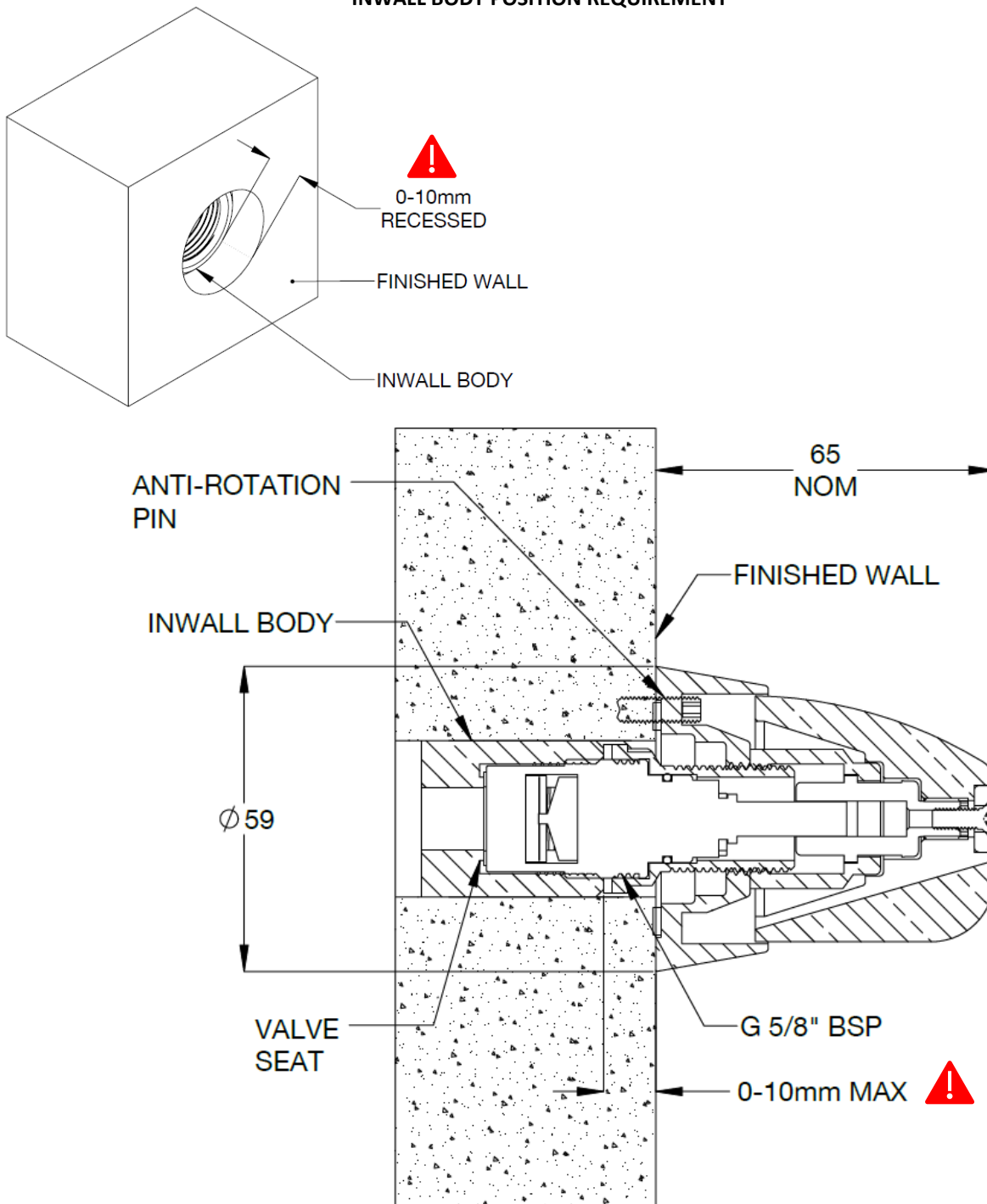

INSTALLATION

INSTALLATION COMPLIANCE: Galvin Engineering products must be installed in accordance with these installation instructions and in accordance with AS/NZS 3500, the PCA and your local regulatory requirements. Water and/or electrical supply conditions must also comply to the applicable national and/or state standards. Failing to comply with these provisions shall void the product warranty and may affect the performance of the product.

IMPORTANT: Whilst our product designs take into account a broad range of installation types and surfaces, it is important that surfaces which fixtures are mounted to are flat and free from defect. This is especially important when installing product ranges that have been designed for correctional and health facilities, where special attention is required to minimise ligature points and areas for concealment of contraband. In addition to ensuring the products are fitted securely and in accordance with the following instructions, consideration shall be given to the use of non-pick mastics such as BASF Sonolastic “Ultra” to ensure a high quality and safe installation.

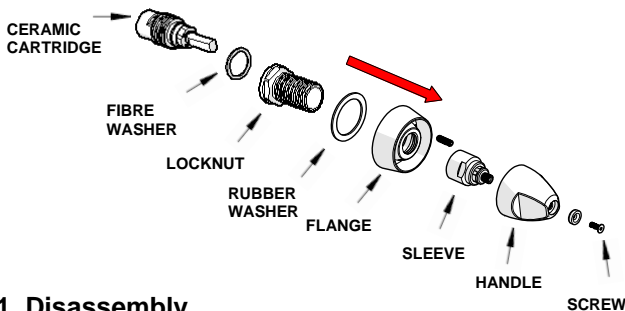

1. Disassembly

- Disassemble components by removing screw first using hex key, leaving bottom nut on the body.
- Separate body washer, cartridge and locknut

2. Fit cartridge

- Fit ceramic cartridge in to the wall body. Fit body washer
- The 1/4 turn ceramic head part **MUST** be fitted into the wall body. **DO NOT** tighten cartridge by using the spindle or the threaded sleeve.

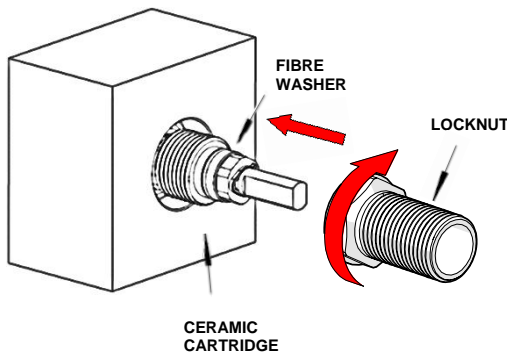
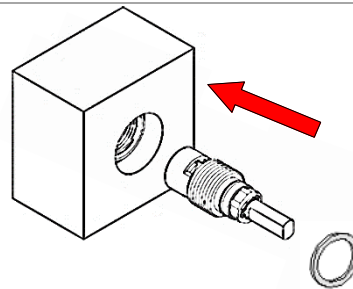

3. Fit locknut

- Fit locknut & tighten onto the cartridge, ensure fiber washer seals, similar tension as conventional jumper valve headpart.

4. Fit dress flange

- Fit dress flange onto locknut and tighten.
- Ensure to use flange washer between wall and flange.

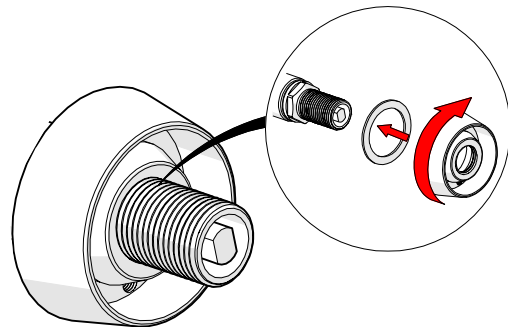

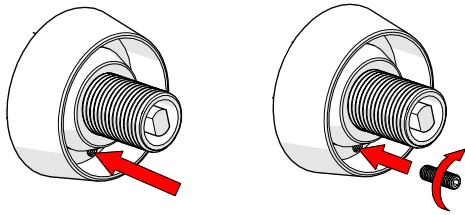

5. Fit dress flange with anti-rotation pin

- If the anti-rotation option is required, fit dress flange onto body and mark the basin/sink, remove the flange and drill 10mm deep diameter 6.0mm hole.
- Replace the flange and screw in the grub screw to lock.

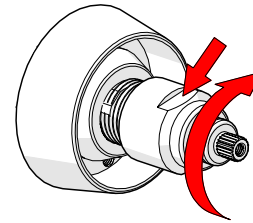

6. Fit lock sleeve

- Fit lock sleeve and tighten.

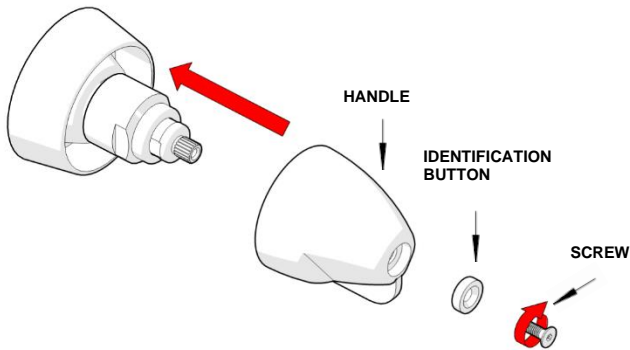

7. Assemble handle

- Fit handle with tamper proof screw, ensure the correct water temperature identification button is in the handle.
- Screw must be tightened before the unit is tested

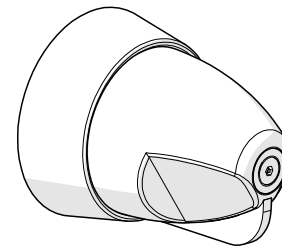

8. Testing

- Check the operation of the unit and inspect for any leaks.

TROUBLESHOOTING

PROBLEM	CAUSE	RECTIFICATION
Taps are dripping water	Ceramic cartridge is worn or damaged	Remove and inspect the cartridge, remove debris and/or replace cartridge if damaged
Water is not flowing from tap	Water is turned off	Turn on water

WARRANTY

The warranty set forth herein is given expressly and is the only warranty given by the Galvin Engineering Pty Ltd. With respect to the product, Galvin Engineering Pty Ltd makes no other warranties, express or implied. Galvin Engineering Pty. Ltd. hereby specifically disclaims all other warranties, express or implied, including but not limited to the implied warranties of merchantability and fitness for a particular purpose.

Galvin Engineering Pty Ltd products are covered under our manufacturer's warranty available for download from www.galvinengineering.com.au Galvin Engineering Pty Ltd expressly warrants that the product is free from operational defects in workmanship and materials for the warranty period as shown on the schedule in the manufacturer's warranty. During the warranty period, Galvin Engineering will replace or repair any defective products manufactured by Galvin Engineering without charge, so long as the terms of the Manufacturer's warranty are complied with.

The remedy described in the first paragraph of this warranty shall constitute the sole and exclusive remedy for breach of warranty, and Galvin Engineering Pty Ltd shall not be responsible for any incidental, special or consequential damages, including without limitation, lost profits or the cost of repairing or replacing other property which is damaged if this product does not work properly, other costs resulting from labour charges, delays, vandalism, negligence, fouling caused by foreign material, damage from adverse water conditions, chemical, electrical or any other circumstances over which Galvin Engineering has no control. This warranty shall be invalidated by any abuse, misuse, misapplication, improper installation or improper maintenance or alteration of the product.