

Product Installation Guidelines

Version 1, 4 June 2024, Page 1 of 4
Document No.: 001.00.30.30

Ezy-Push® CP-BS Lead Safe™ Timeflow Push Button Pillar Taps

PRODUCT CODES:

- 173.15.21.00 – 6 sec.
- 173.15.41.00 – 15 sec.



Ezy-Lever® CP-BS Lead Safe™ Timeflow Lever Action Vandal Resistant Pillar Tap

PRODUCT CODES:

- 173.15.23.00 – 6 sec.

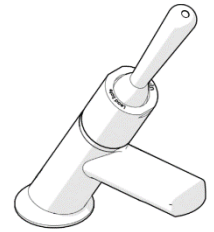

SPECIFICATIONS

- Time flow taps are designed to operate at full mains pressure.
- The valve has a unique self-closing operation.
- The taps are made of chrome plated Lead Safe™ DR Brass*.
- Clean hygienic design.
- Water saving and vandal resistant.
- Low maintenance and easy to operate.
- Supplied with hot (red), warm (yellow) and cold (blue) buttons depending on the requirement.
- Smooth round designs to facilitate easy clean and help reduce dirt and bacteria growth.

Note: Time is based on 500kPa, @ 22 degrees Celsius. Time will vary plus or minus 30% based on water temperatures, pressures, flow rates and water quality.

**Our Lead Safe™ product range is compliant with the Lead-Free Requirements of the NCC 2022 Vol. Three, Clause A5G4(2) and NSF/ANSI 372.*

IMPORTANT: All Ezy-Push® Time Flow Pillar Taps are tested in accordance with AS/NZS 3718 and leave our premises in good working order. Time may vary due to changes in temperature, pressure, flow rate and water quantity.

WARNINGS: Special attention to be paid on notes, photos, images, or drawings of assembly steps marked with the warning symbol.



TECHNICAL DATA

Inlet	G ½" - Male	
Outlet	Flow Straightener	
Headwork	Time Flow Cartridge	
Working Pressure Range (kPa)	Min	100
	Max	500
Maximum Working Temperature (°C)	Min	5
	Max	65
Nominal Flow Rate (LPM)	4.9	
Construction	Brass	
Finish	Chrome	

NOTE: Galvin Engineering continually strive to improve their products. Specifications may change without notice.

TOOLS REQUIRED

- Power drill
- Spanner or adjustable crescent
- Screwdriver

PRE-INSTALLATION

MOUNTING DETAILS – HOLE CENTRES

- If the mounting holes do not already exist, mark out and drill the holes in the bench/trough, as shown in rough in dimensions.

⚠ Note: Before installation, all lines must be flushed. We recommend that a line strainer be installed prior to

Ezy-Push Time Flow Pillar taps to eliminate any foreign material.

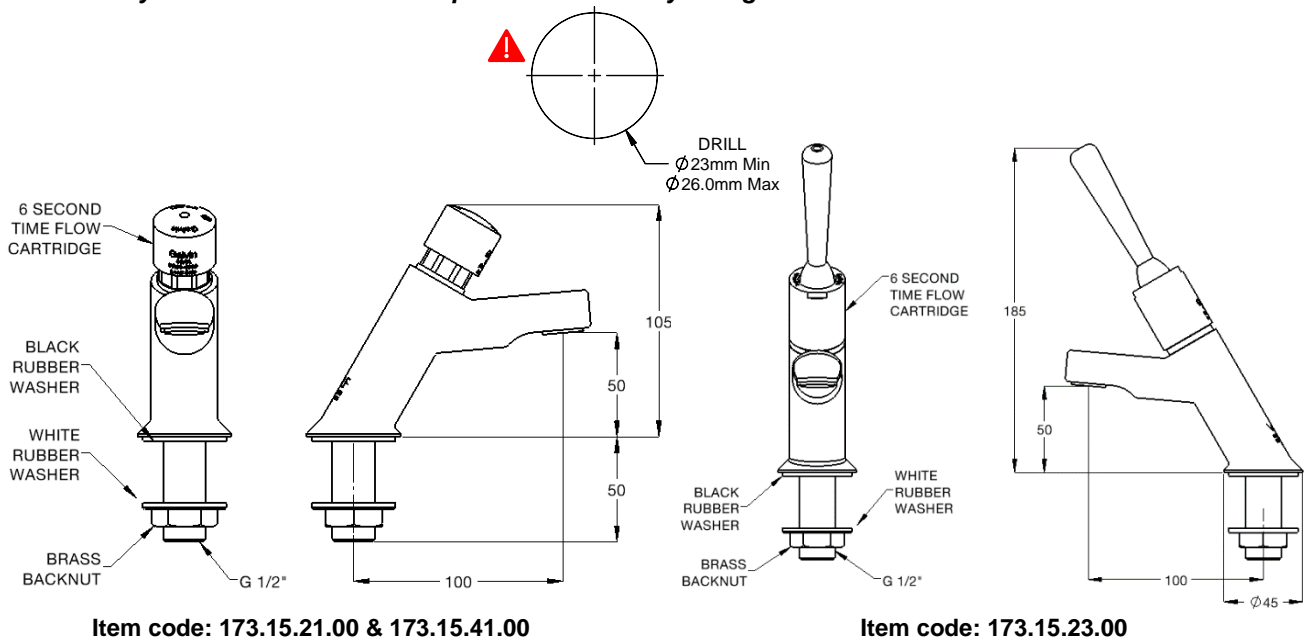

INSTALLATION

IMPORTANT: Galvin Engineering products must be installed in accordance with these installation instructions and in accordance with AS/NZS 3500, the PCA and your local regulatory requirements. Water and/or electrical supply conditions must also comply to the applicable national and/or state standards. Failing to comply with these provisions shall void the product warranty and may affect the performance of the product.

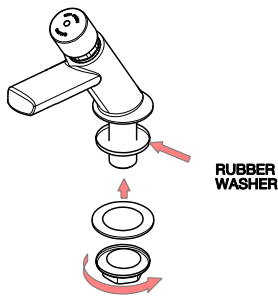

Item code: 173.15.21.00
Item code: 173.15.41.00

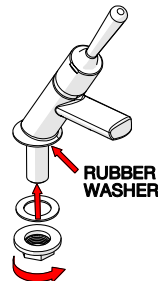

Item code: 173.15.23.00

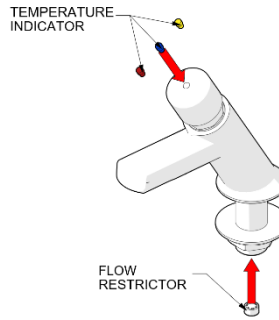

Item code: 173.15.21.00
Item code: 173.15.41.00

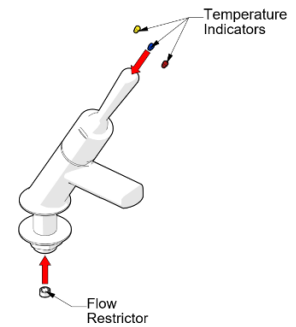

Item code: 173.15.23.00

1. Fit tap assembly

- Fit the tap body into the bench. Ensuring one of the sealing rubber washers is placed underneath the tap body.
- Secure underneath with the other sealing rubber washer and back nut.
- Time flow taps are fitted with flow restrictors.
- When applying thread tape or sealant to the inlet, ensure the opening is not obscured. Failure to do so may restrict or block the flow restrictor, affecting the flow of water.

2. Replacing flow restrictor (if required) and fitting water temperature indicator

- Major restrictions to the supply pressure (eg. refrigeration units) may affect the water stream and the flow restrictor may need replacing with a restrictor of greater capacity to increase the flow. However, using a different flow restrictor will void the 6-star rating.
- Never operate without a flow restrictor, as Time flow taps will deliver full mains pressure with unrestricted flow.
- Fit the appropriate water temperature indicators (Cold, Hot, or Warm).

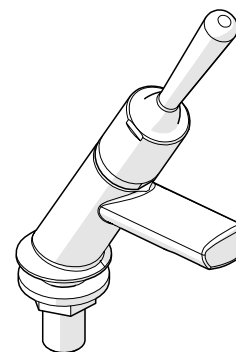
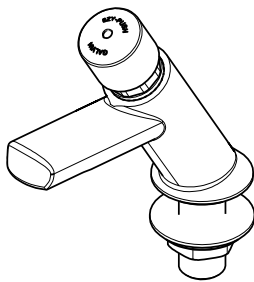

3. Testing

- Once fitted, connect the water lines & turn on water.
- Check for leaks and correct operation.

TROUBLESHOOTING		
PROBLEM	CAUSE	RECTIFICATION
Water is not flowing or inconsistent flow.	Blocked flow restrictor / dirt in the cartridge / water supply not on.	Remove flow restrictor from outlet and remove debris. Install an in-line strainer to stop further blockages. Ensure water supply is turned on.
Continous flow of water.	Top assembly cartridge loose or internally obstructed or damaged.	Remove cartridge, clean with water and regrease spindle if required.
Rate of flow inadequate.	The flow restrictor may not be satisfactory due to inadequate supply pressure.	Remove flow restrictor and replace with a flow restrictor of different capacity to suit (available from Galvin Engineering).
Button hard to activate.	Mains pressure may be too high.	Reduce mains pressure to below 500kPa.
Water shuts off upon release the button.	Small spring at the bottom of the cartridge piston dislodged.	Relocate spring, regrease spindle if required.

WARRANTY

Galvin Engineering products are covered under our Manufacturer's Warranty. Galvin Engineering products must be installed in accordance with the installation instructions and in accordance with AS 3500 and NCC Volume Three, relevant Australian Standards and local authorities applicable to product being installed. Water and electrical supply conditions must also comply to the applicable national and/or state standards, failing to comply with these provisions may void the product warranty and affect performance of the product.

Please visit www.galvinengineering.com.au to view the full warranty, our Installation Compliance and Maintenance & Cleaning information as well as any other additional information.