

Product Installation Guidelines

Version 1.1, 30 April 2021, Page 1 of 11

Flowmatic® SS Face Plate w/ Concealed 24v AC Wall Sensor

PRODUCT CODE:

- TZ-FLOWSENC24

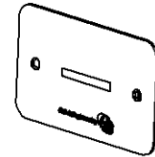

SPECIFICATIONS

- Flowmatic® automatic concealed wall assembly is an aesthetically pleasing, single temperature water control unit, which can be used for hand basins, sinks, or any application to initiate a controlled flow of water.
- The multiple time cycle option is able to be adjusted on site which provides the facility manager the flexibility of adjusting to suit user requirements.
- Sensor circuit boards are supplied standard with a lacquer finish to limit the damage that may be caused by moisture
- Built in capacitors and easy fit electrical filters help suppress external noise and provide a continuous, reliable delivery of water.
- 1.5mm thick stainless steel face plate with hand activation sensor. It is designed to be mounted flush into the wall/trough.
- Flowmatic® Wall sensor controller is a 24V AC electronic control system that can be used in various applications. Controller is pre-programmed and ready to use. The solenoid will open for a specific time once the sensor will detect hands movement. The standard program can be modified to suits individual needs. To modify the operation settings a compatible Android device with Bluetooth is required.

TECHNICAL DATA

Power Supply (Required – not supplied) 	Type	Transformer
	Input	240V - 50Hz 30VA
	Output	24V - 917mA Max 22VA
Sensor	Type	Infra-Red
	Activation	Hand movement
Controller	Input Voltage	24V AC
	Program type	Flowmatic
	Connections	Terminal Plug 2 way 3.81mm
Finish (user)		Stainless Steel
Nominal Flow Rate (LPM)		N/A

NOTE: Galvin Specialised continually strive to improve their products. Specifications may change without notice.

PRE - INSTALLATION

IMPORTANT:

- **INSTALLATION COMPLIANCE:** Galvin Specialised products must be installed in accordance with these installation instructions and in accordance with AS/NZS 3500, the PCA and your local regulatory requirements. Water and/or electrical supply conditions must also comply to the applicable national and/or state standards. Failing to comply with these provisions shall void the product warranty and may affect the performance of the product (Refer to installation compliance sheet supplied with the product).
- Ensure that access to the sensor, solenoid valve and transformer/GPO is available for future maintenance when installing the components. It is recommended that isolating valves be installed upstream to the solenoid valve to allow for servicing. All wiring must be able to be removed when installed into cavities or walls, therefore, it is recommended that a minimum of 25mm conduit be used to house the leads. The unit is supplied with 3 meters of lead on the transformer and a 5 meters lead from the solenoid. Additional lead lengths may be accommodated up to a length of 5m but must be ordered separately.
- Whilst our product designs take into account a broad range of installation types and surfaces, it is important that surfaces which fixtures are mounted to are flat and free from defect. Additionally, ensure any protruding connecting thread is square to the wall so that the outlet sits flat against the wall when installed. This is especially important when installing product ranges that have been designed for correctional and health facilities, where special attention is required to minimise ligature points and areas for concealment of contraband. In addition to ensuring the products are fitted securely and in accordance with the following instructions, consideration shall be given to the use of non-pick mastics such as BASF Sonolastic "Ultra" to ensure a high quality and safe installation.
- Most installation problems are due to damage to the unit during installation or the selection of an inappropriate installation location. Select the location carefully and take care with the installation, consider ease of operation for the end user.
- It is advised that the sensor should not be positioned directly in front of reflecting surfaces, such as ceramic tiles, stainless steel basins or mirrors. Any bright lighting reflecting off a highly reflective surface such as a stainless steel basin, or a high visibility reflective vest, may interfere with correct sensor operation (Refer sensor settings for operation and adjustment)

GENERAL INSTALLATION REQUIREMENTS

- Do not cut or extend the existing leads without using a correct lead extension from Galvin Specialised, as this will void warranty.
- Suitable access to the service of all components must be provided.
- Do not apply heat near this product when connecting water lines. Heat generated by soldering could damage plastic or electrical parts and seals, and will void the warranty.
- For personal installation assistance and spare parts, please call our head office on 1300 514 074 and speak to our customer service staff.

MOUNTING DETAILS

Face plate cut out position

- A position above and to the right of the water outlet is ideal. The best way to select the location is to stand centrally in front of the outlet and extend your right forearm in front of you in a natural arc. Be sure that passing traffic cannot trigger the sensor. Allow at least 400mm clearance.
- Ensure that when selecting a mounting position nothing is within range of the sensor. If the sensor unit is installed into a location where a nearby wall or object is reflecting the Infrared light back, the unit is effectively blinded and will not operate. It is similar to having a torch shone into your eyes.

Note: Outlets are not supplied and must be ordered separately.

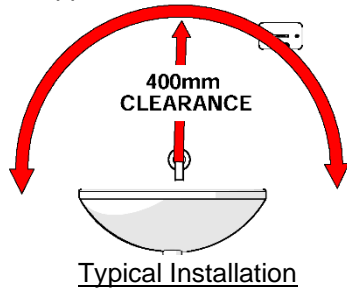

Cut out details for Galvanised box (not supplied as a standard)

- If the unit is supplied with a Galvanised Inwall electrical box and stainless steel face plate. Assembly should be mounted flush to the wall over a 98mm x 60mm cut-out. Ensure wall depth is between 45mm minimum - 70mm maximum from finished wall surface to the back of box.

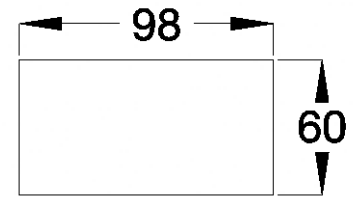

⚠ Do not install sensor under the spout.

COMPONENT DIMENSIONS

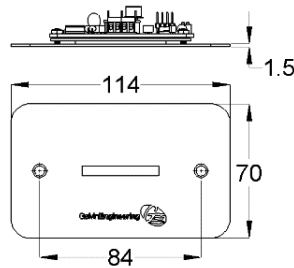

TZ-FLOWSENC24- STAINLESS STEEL FACE PLATE WITH CONCEALED WALL SENSOR ASSEMBLY

INSTALLATION

⚠ Avoid common installation errors :

- Non-compliance to Australian Standards.
- No access for service.

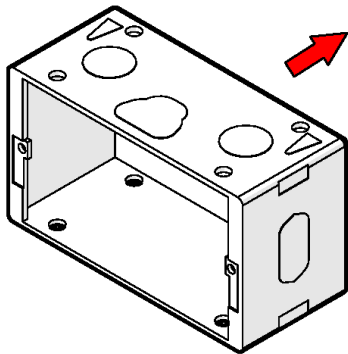

(NOT SUPPLIED)

1. Mount galvanised electrical box (not supplied)

- Mount galvanised box into the wall 1 or 2mm below the finished wall surface.
- The galvanised box can be fixed to a masonry wall or wall frame using screws suitable for the fixing method. (Fasteners to be supplied by installer).
- **If more lead is required extension leads are available. In this case please contact Galvin Specialised**

Note: For the galvanized box supply and orders please contact Galvin Specialised

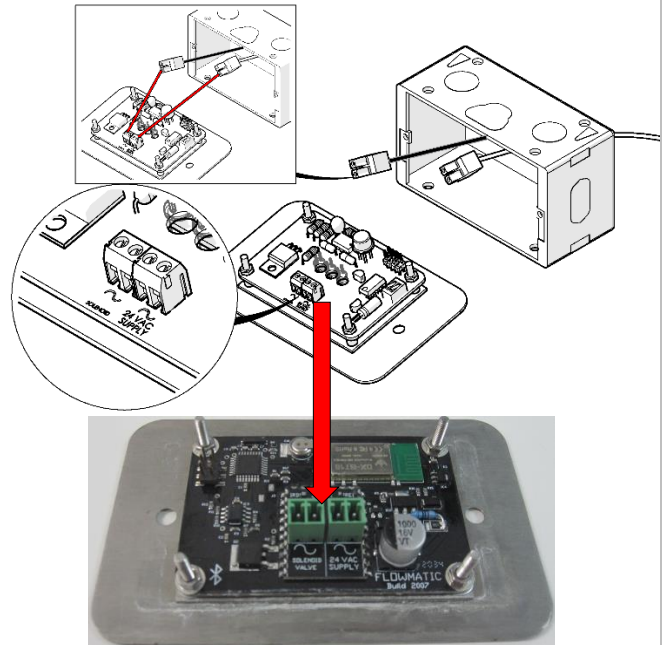

2. Connect to sensor plug

- **We recommended that all cabling is fed through 25mm conduit to make servicing and replacment easier.**
- Connect the transformer plug to the rear of the Sensor, observing the correct plug connection.
- **If more lead is required extension leads are available. In this case please contact Galvin Specialised.**

⚠ Do not cut the leads. If the leads are too long, it is recommended that any excess is coiled up and clipped to the wall.

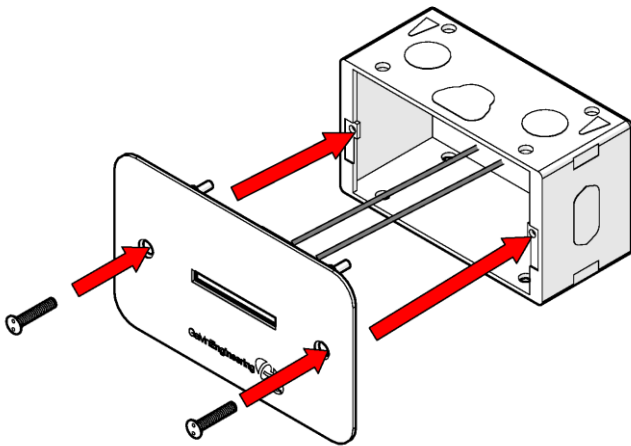

3. Mount face plate

- We recommend that all cabling is fed through 25mm conduit to make servicing and replacement easier.
- Apply a thin bead of silicon on the edge of the wall cut out.
- Fit the face plate using screws suitable for the fixing method. (Fasteners to be supplied by installer).
- **If extension leads are required, please contact Galvin Specialised.**



Do not force the faceplate to fit onto wall or attempt to disassemble components, as this could result in damage to sensor.

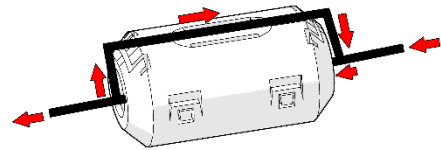

4. Secure wiring with suppressor (not supplied)

- Connect the electrical interference suppressor to each cable (1x Transformer, 1x Solenoid Lead) as shown and ensure they are as close to the sensor face as possible



All electrical components should be protected from contact with water or excessive heat and installed in accordance with local regulations.

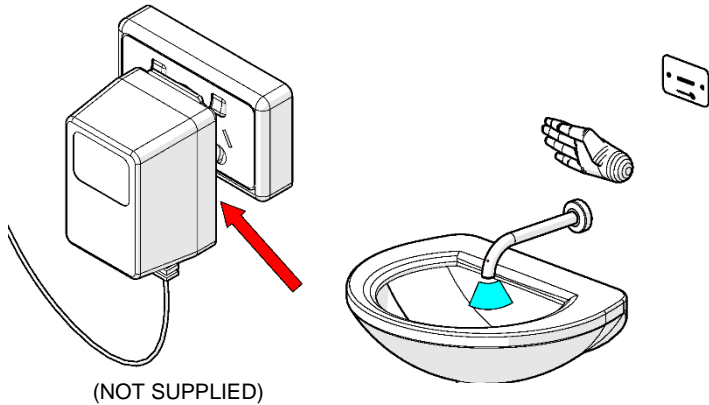

Typical Installation

5. Connect power supply & Check for correct operation

- The 24V AC transformer (not supplied) is plugged into a standard mains power point (GPO).
- Turn on the power point and test the unit.
- Wave the back of your hand through the beam to turn the water on and again to turn the water off.
- The sensor may require adjustment. Please ensure that the sensor is in a position that reflects the actual installation

Note: The sensor is factory set to medium and will need to be adjusted to suit individual installations.

⚠ All electrical components should be protected from contact with water or excessive heat and installed in accordance with local regulations.

⚠ The connection of this product to mains power supply should be undertaken by a competent person and should conform to local Wiring Regulation – AS3000 Wiring rules.

Note: For transformer supply and orders please contact Galvin Specialised

CONTROLL MODULE PROGRAM MODIFICATION

Required to make changes to the controller settings :



- Android device (e.g. smartphone, tablet).
- Installed from PlayStore 'Flowmatic system' software. Locate and download 'Flowmatic Syatem' software.

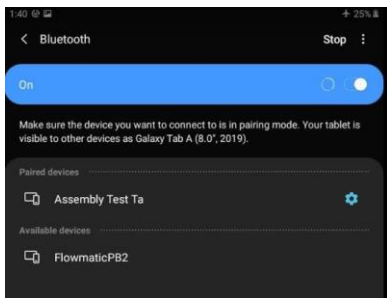
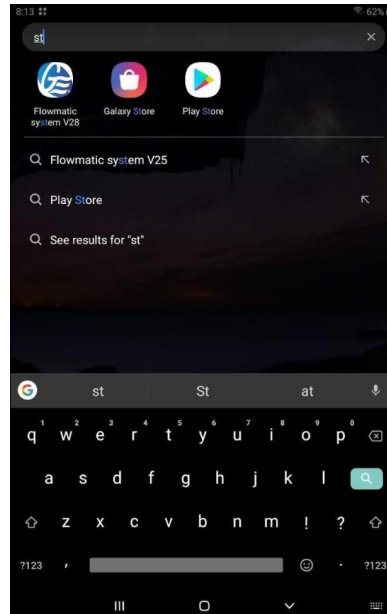

1. Establish Bluetooth connection

- Go to the Bluetooth settings on your device then scan for devices. Generally, when scanning the first thing to come up in available devices will be a Mac address that looks like this example (AB:EC:69:57:34:02). This will eventually change to the name of the device (this can be changed to a custom name in the app).
- Select this device.

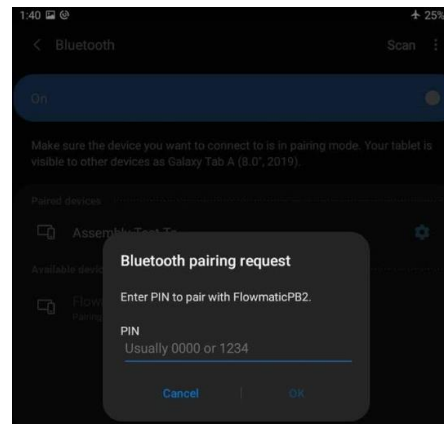

2. Entering the pin

- The device will ask for a pin, which from factory is '1234'. Enter this in. (This pin can be changed later in the app.). Your device is now connected to the controller, and is ready to be adjusted from the 'Flowmatic system' app.

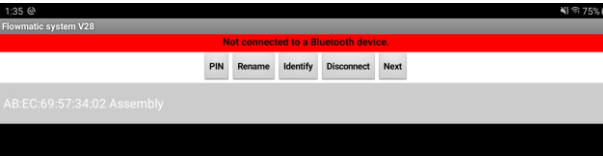

3. Changing controllers settings

- Open the Flowmatic system' app. The device will appear on the screen. with Mac Address first and then controller name e.g. 'AB:EC:69:57:34:02 Flowmatic'.
- Select the Flowmatic, this will then update the controllers time clock, and then open the setting screen by pressing 'Next'.

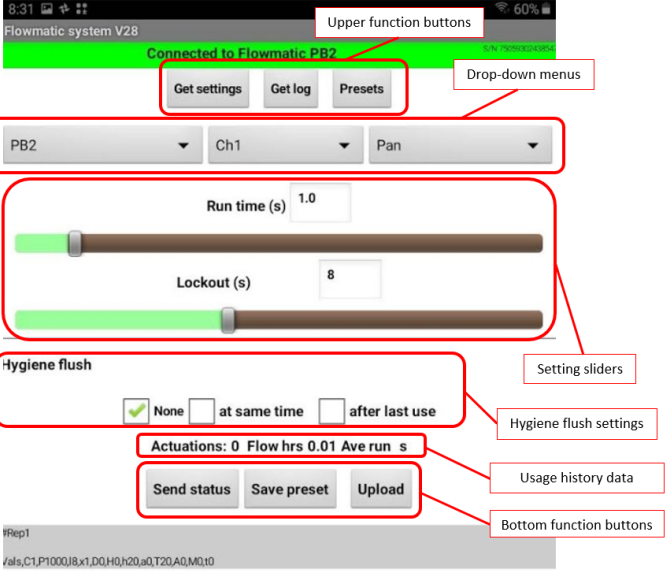

4. Setting screen overview.

- **Upper function buttons.** By pressing the 'Get settings' button the currently stored parameters in the controller's internal memory will be downloaded to the app. The 'Get log' button will pop up the log data screen. The 'Presets' button will list all saved presets.
- **Drop-Down menus.** First menu from left is to select the type of controller the app is connected to. The second menu is to select which 'channel' is going to have parameters changed (only for PB2). The third menu is to declare what is the controlled feature designed for (only for PB2).
- **Setting sliders.** Depending on the selected controlled feature there will appear one, two or three setting sliders.
- **Hygiene flush setting** menu allows to set the time and intervals of hygiene flush.
- **Bottom function buttons** are to be used to manage the controller internal memory.

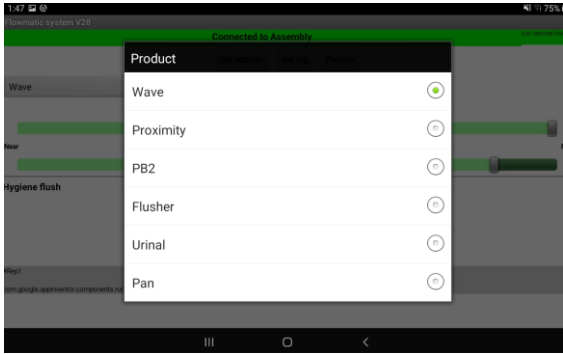

- 5. Type of controller (left drop-down menu)**
- For the TZ-FLOWTAPC24 controller the 'Wave' or 'Proximity' selection may be used depending on the application. Please **do not** change the selection to the , 'Urinal', 'Pan' 'PB2' or 'Flusher'.

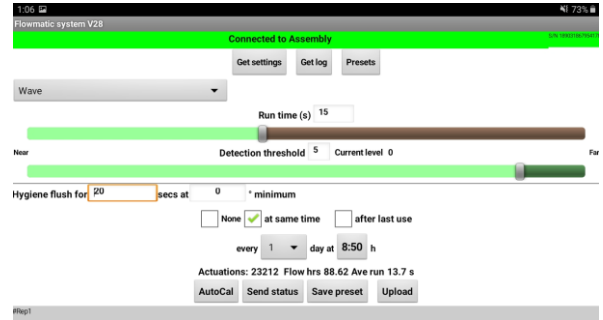

- 6. 'Wave', 'Proximity' setting screens contains the same setting parameters.**
- Run time (s) slider – to set the required flow time.
 - 'Detection threshold' slider – to set sensing range. By setting smaller value the detection distance is farther. Bigger value is making the detection distance shorter.

7. Choosing the suitable mode

- **'Wave' mode:**
 - If a hand is detected, the water will start and keep flowing until the time set in the 'Run time' section will pass or another 'wave' will appear in front of the sensor.
- **'Proximity' mode:**
 - If a hand is detected, the water turns on for as long as the hand is there, up to a certain timeout value set in the 'Run time' section.
- **'Urinal' mode:**
 - When a user is first detected in front of the sensor, the cycle is triggered so that a timer starts when the user leaves. At the end of this timed period, the solenoid valve is actuated to flush the urinal and the cycle is then reset.
- **'Pan' mode:**
 - When a user is first detected in front of the sensor, a timer starts. After a pre-set time, if the user is still there, the sensor decides that a full flush will be required, otherwise, only a half flush will be triggered. This flush happens a set time after the user leaves the immediate vicinity

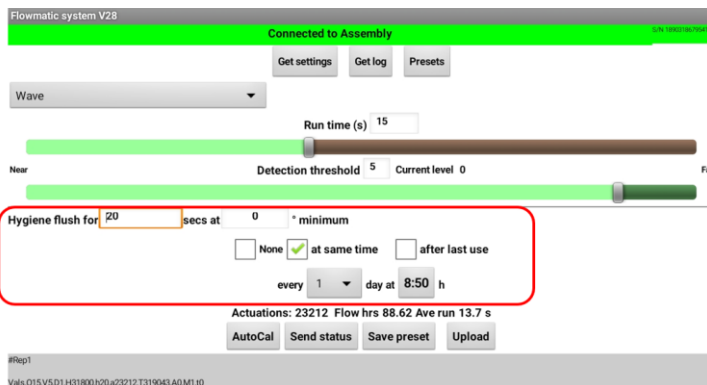

- 8. Settings 'Hygiene flush'.**
- Set the required time for Hygiene flush and press 'Upload'.

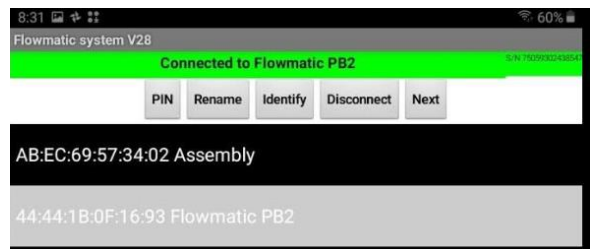

- 9. Connection menu.**
- By pressing the back arrow, the connection screen will pop up. The buttons allow to rename the controller, set new PIN, disconnect, or go to setting screen 'Next'.

TROUBLE SHOOTING

PROBLEM	CAUSE	RECTIFICATION
Sensor Not Responding	Damaged or scratched lens	Replace Sensor Unit
	Sensor lead damaged	Replace sensor lead
	No Power	Check power is reaching transformer
	Waving Hand too fast past the sensor	Slow down the action in front of the sensor
	Transformer faulty	Replace transformer
False Activation	Electrical interference	Ensure electrical suppressors are installed correctly
	Reflection from a light source	Re-align sensor or shield light source
No water flow	Sensor not responding	Check fault relating to sensor
	No power	Check power is reaching transformer
	Power supply leads joined incorrectly	Replace electronic components
	Water or structural damage to electrical components	Replace damaged electrical components
	Incorrect connections	Check all connections
	Damage to sensor lead or power supply lead	Check and replace lead & controllers
	Water corroded electrical connections	Replace electronic components

MAINTENANCE INSTRUCTIONS

Sensor:

-  **The Electronic Sensor is a non serviceable product. If damaged the sensor must be replaced.**
- Turn power off at GPO.
- Unscrew the two fixing screws. The silicon seal may have to be cut with care to free the sensor.
- Unplug the solenoid plug and transformer plug from the rear of the sensor. Generally, if the sensor has been damaged by an electrical surge, it is recommended that the transformer be replaced at the same time.
- Replace the sensor and reconnect the new sensor. Plug the solenoid and transformer plugs back onto the rear of the sensor. Fix the sensor panel back onto the galvanised inwall box with the existing screws.

 **Important: Seal the stainless steel face panel and screws using silicon, ensuring it has a water tight seal.**

Note: Before attempting to replace any of these items check that you have access to re-run the connection leads. If you do not have access or you have any doubts please contact Galvin Specialised for advice before commencing replacement.

WARRANTY

The warranty set forth herein is given expressly and is the only warranty given by the Galvin Engineering Pty Ltd. With respect to the product, Galvin Engineering Pty Ltd makes no other warranties, express or implied. Galvin Engineering Pty. Ltd. hereby specifically disclaims all other warranties, express or implied, including but not limited to the implied warranties of merchantability and fitness for a particular purpose.

Galvin Engineering Pty Ltd products are covered under our manufacturer’s warranty available for download from www.galvinengineering.com.au Galvin Engineering Pty Ltd expressly warrants that the product is free from operational defects in workmanship and materials for the warranty period as shown on the schedule in the manufacturer’s warranty. During the warranty period, Galvin Engineering will replace or repair any defective products manufactured by Galvin Engineering without charge, so long as the terms of the Manufacturer’s warranty are complied with.

The remedy described in the first paragraph of this warranty shall constitute the sole and exclusive remedy for breach of warranty, and Galvin Engineering Pty Ltd shall not be responsible for any incidental, special or consequential damages, including without limitation, lost profits or the cost of repairing or replacing other property which is damaged if this product does not work properly, other costs resulting from labour charges, delays, vandalism, negligence, fouling caused by foreign material, damage from adverse water conditions, chemical, electrical or any other circumstances over which Galvin Engineering has no control. This warranty shall be invalidated by any abuse, misuse, misapplication, improper installation or improper maintenance or alteration of the product.