

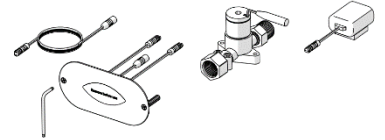

# Flowmatic® Wave On Activated Concealed Sensor With Solenoid, Battery Powered



PRODUCT CODE:

- TZ-IQWAVEB

TECHNICAL DATA			
Inlet		1/2" BSP – Female	
Outlet		1/2" BSP - Male	
Headwork		Solenoid	
Battery (VDC)		6	
Solenoid	Input Voltage		6.75V DC
	Power Consumption		-
	Cable length		3.2m
	Pressure Range (kPa)	Min	50
		Max	500
	Temperature (°C)	Min	5
Max		80	
Finish		SS Faceplate	
<p><b>NOTE:</b> Galvin Specialised continually strive to improve their products. Specifications may change without notice.</p>			

SENSOR DETAILS	
• Hardware	Varox 4.2.2
• Software	IQ7VARIR2V 7.15-0256, release 15.5.2015
• Input Voltage	6.75V DC – 0.5A
• Cable length	3.2m
• Sensor function	Standard washbasin (with proximity sensor)
• Preset line purge feature interval:	12 hours after last flush, water flow duration 3 min
• Preset continuous run:	5 min
• Sensor range:	Sensor1 and Sensor2 custom made steps

TOOLS REQUIRED
<ul style="list-style-type: none"> <li>- Power drill</li> <li>- Spanner or adjustable crescent</li> <li>- Screw driver</li> </ul>



## DIMENSIONS

- A cavity must be supplied to fit sensor on the back of faceplate as shown, minimum 20mm deep.
- Drill 2 x mounting  $\varnothing 6.0 \times 30$  deep holes, location as shown.

**Note:** See below for a typical installation of the sensor position from basin.

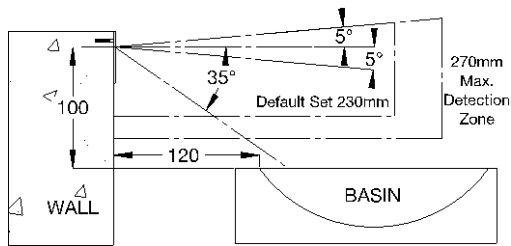

Typical Installation

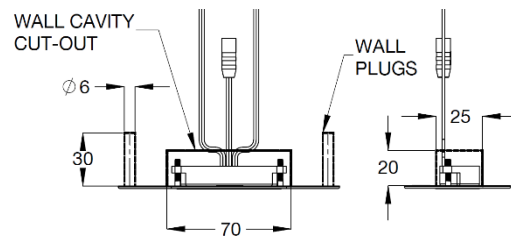

Wall Plugs & Cut-out Details

3.2m LONG  
EXTENSION  
WITH 2 PIN  
PLUGS

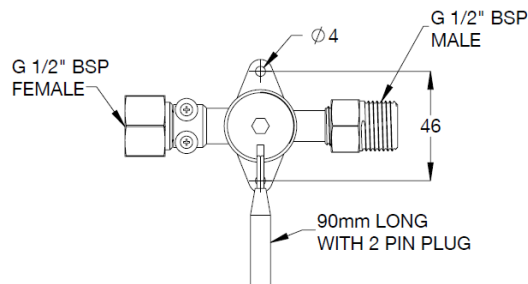
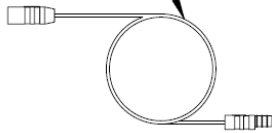

165mm  
LONG

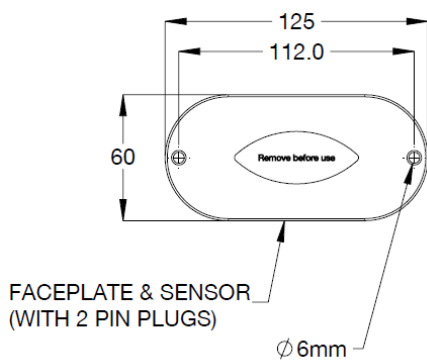
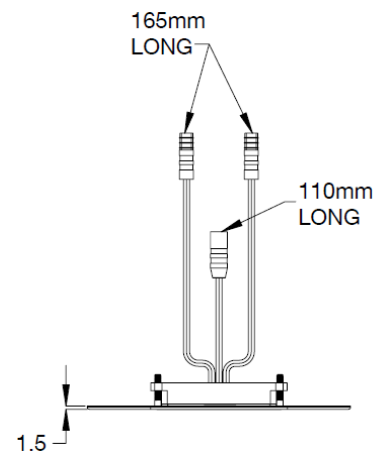

FACEPLATE & SENSOR  
(WITH 2 PIN PLUGS)

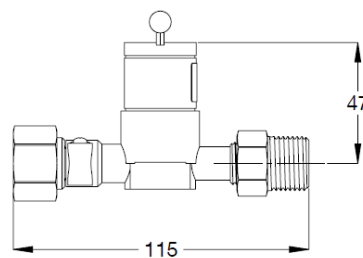

BATTERY PACK  
6V DC

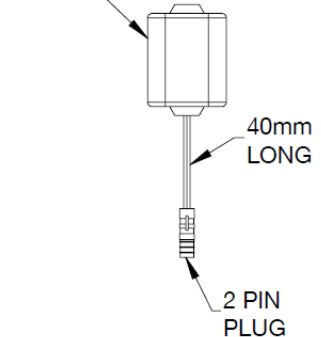

## INSTALLATION

**INSTALLATION COMPLIANCE:** Galvin Specialised products must be installed in accordance with these installation instructions and in accordance with AS/NZS 3500, the PCA and your local regulatory requirements. Water and/or electrical supply conditions must also comply to the applicable national and/or state standards. Failing to comply with these provisions shall void the product warranty and may affect the performance of the product.

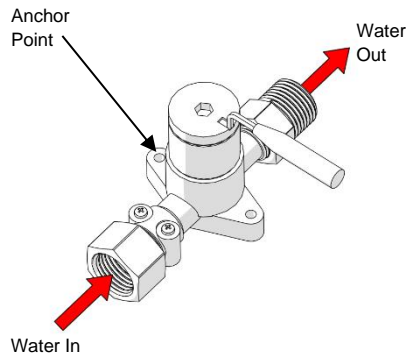

### 1. Fit solenoid

- Before installation, all lines must be flushed. We recommend that a line strainer be installed prior to the solenoid to eliminate any foreign material.
- Ensure the solenoid is mounted using the 2 anchor points shown and is in a suitable location.
- Connect mains water and the outlet using thread tape/sealant.

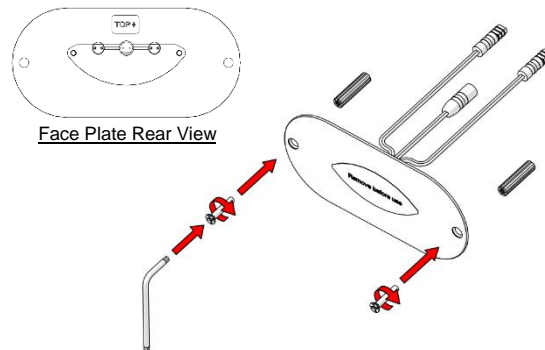

### 2. Fit faceplate

- Before fitting the faceplate refer to the Dimensions section to ensure a suitable location has been selected for correct operation.
- Fit the supplied wall plugs following the Dimensions section.
- Ensure the faceplate is orientated correctly. On the rear of the face plate (pictured) is a sticker indicating the correct orientation.
- Fit and secure the faceplate using the supplied screws and tool.

 **Do not remove the black label covering the sensor until the tap is to be commissioned.**

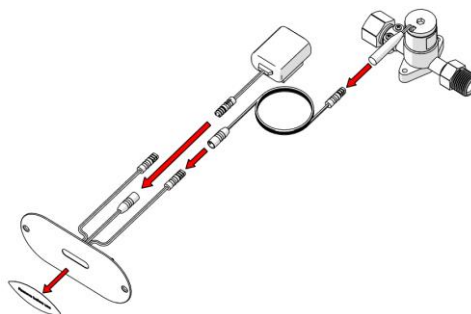

### 3. Fit connections and test

- The extension cable can be used for either the battery or the solenoid.
- Connect the solenoid to either of the male connections on the rear of the sensor and the battery to the female connection (as shown).
- Remove label covering the sensor.
- Start sensor; Refer to the following section – **Sensor Setting Instructions**
- Check for any leaks and correct operation.

SENSOR SETTING INSTRUCTIONS					
Signs and symbols		Touch function			Hand/object within sensor area
		Water flows			LED flashes Green
		Water flow stop			LED flashes Red
	H – hours / min. – minutes / sec. - seconds				

FUNCTION	PROCEDURE	FEEDBACK SIGNAL	INFORMATION	DEFAULT	SETTING RANGE Via IQUA Touch
<b>First startup</b> After installation	1x  app. 4 sec. till		Remove hand/object from sensor area	-	-
	wait	+	2x/sec., keep out of sensor area		
	wait till	1x	Confirmation, ready for operation		
<b>Temporary off</b> «Cleaning mode» Activate	1x  app. 2 sec. till	1x	Extended function mode is active	2 min.	
	2x  a app. 0.5 sec		Pulsing during active function		
<b>Temporary off</b> Stop	1x  app. 2 sec.	1x	Manual stop		
	or automatic	1x	Automatic after preset time		
<b>Continuous run</b> Activate	1x  app. 2 sec. till	1x	Extended function mode is active	5 min.	0.5-20 min. (in 0.5 steps) min.
	1x  minimum 3 sec. (max. 5 sec.)		Water flows after releasing		
<b>Continuous run</b> Stop	1x  app. 2 sec.		Manual stop		
	or automatic		Automatic after preset time		
<b>Follow up Time control</b> For normal operation Set / program	1x  app. 2 sec. till	1x	Extended function mode is active	1 sec.	0-10 sec.
	1x  app. 5 sec. till	1x			
	1x  0 - 10 sec. Keep touched	+	1x/sec., water flows during touching - releasing defines duration		
	after releasing	1x	Confirmation, ready for operation		



**Product Installation Guideline**

Version 1, 25<sup>th</sup> March 2020 Page 5 of 6

<b>Time of water flow For continuous run</b>	1x  app. 2 sec. till	1x	Extended function mode is active	5 min.	0.5-20 min  (in 0.5 min steps)
	1x  minimum 3 sec. (max. 5 sec.)	+	Touch max. 5 sec., water flows after releasing, number of  (1x-40x) shows current setting		
	1x  keep touched till	1x - 40x	1x  =0.5 min. .... 40x  = 20.0 min. releasing defines duration		
	after releasing	+  1x	check / confirmation of setting by repeating number of  (1x - 40x) according to setting		
<b>line purge feature</b> activate / deactivate << Automatic flush on set interval>> (time of waterflow: 3 min)	1x  app. 2 sec. till	1x	extended function mode is active	12h	Off 12 h 24 h 48 h
	1x  app. 25 sec. till	1x - 4x	1x= off,  2x=12h,  3x= 24h,  4x= 48h ignore flashes after 5 sec. and 10 sec. – keep touched till  1x - 4x after app. 25 sec., releasing defines interval		
	Wait till	1x	Confirmation, ready for operation		
<b>restart electronics</b>	1x  app. 2 sec. till	1x	extended function mode is active		
	2x  a app. 0,5 sec		pulsing during active function		
	1x  app. 5 sec. till	4x	1x/sec.		
	Release and wait till	+	1x/sec., keep out of sensor area		
	Wait till	1x	confirmation, ready for operation		

**TROUBLESHOOTING**

PROBLEM	CAUSE	RECTIFICATION
Sensor Not Responding	<ul style="list-style-type: none"> <li>- Damaged or scratched lens</li> <li>- Sensor length too short</li> <li>- Lead damaged</li> <li>- No power</li> <li>- Waving hand too fast</li> </ul>	<ul style="list-style-type: none"> <li>- Replace the sensor unit</li> <li>- Adjust beam to correct length.</li> <li>- Replace connected item.</li> <li>- Check power is on or replace battery</li> <li>- Slow down the action in front of the sensor</li> </ul>
False Activation	<ul style="list-style-type: none"> <li>- Sensor length too long</li> <li>- Reflection from a light source</li> </ul>	<ul style="list-style-type: none"> <li>- Adjust sensor length to correct length</li> <li>- Re-align sensor or shield light source</li> </ul>
Water is not flowing from outlet	<ul style="list-style-type: none"> <li>- Water is off</li> <li>- Solenoid isn't activating</li> </ul>	<ul style="list-style-type: none"> <li>- Turn on mains water</li> <li>- Remove and check the solenoid for debris. Clean and re-install. Replace solenoid if faulty.</li> </ul>

## WARRANTY

The warranty set forth herein is given expressly and is the only warranty given by the Galvin Engineering Pty Ltd. With respect to the product, Galvin Engineering Pty Ltd makes no other warranties, express or implied. Galvin Engineering Pty. Ltd. hereby specifically disclaims all other warranties, express or implied, including but not limited to the implied warranties of merchantability and fitness for a particular purpose.

Galvin Engineering Pty Ltd products are covered under our manufacturer's warranty available for download from [www.galvinengineering.com.au](http://www.galvinengineering.com.au) Galvin Engineering Pty Ltd expressly warrants that the product is free from operational defects in workmanship and materials for the warranty period as shown on the schedule in the manufacturer's warranty. During the warranty period, Galvin Engineering will replace or repair any defective products manufactured by Galvin Engineering without charge, so long as the terms of the Manufacturer's warranty are complied with.

The remedy described in the first paragraph of this warranty shall constitute the sole and exclusive remedy for breach of warranty, and Galvin Engineering Pty Ltd shall not be responsible for any incidental, special or consequential damages, including without limitation, lost profits or the cost of repairing or replacing other property which is damaged if this product does not work properly, other costs resulting from labour charges, delays, vandalism, negligence, fouling caused by foreign material, damage from adverse water conditions, chemical, electrical or any other circumstances over which Galvin Engineering has no control. This warranty shall be invalidated by any abuse, misuse, misapplication, improper installation or improper maintenance or alteration of the product.